

# XXX-D VIP

1 / 10 EP DRIFT CAR CHASSIS KIT

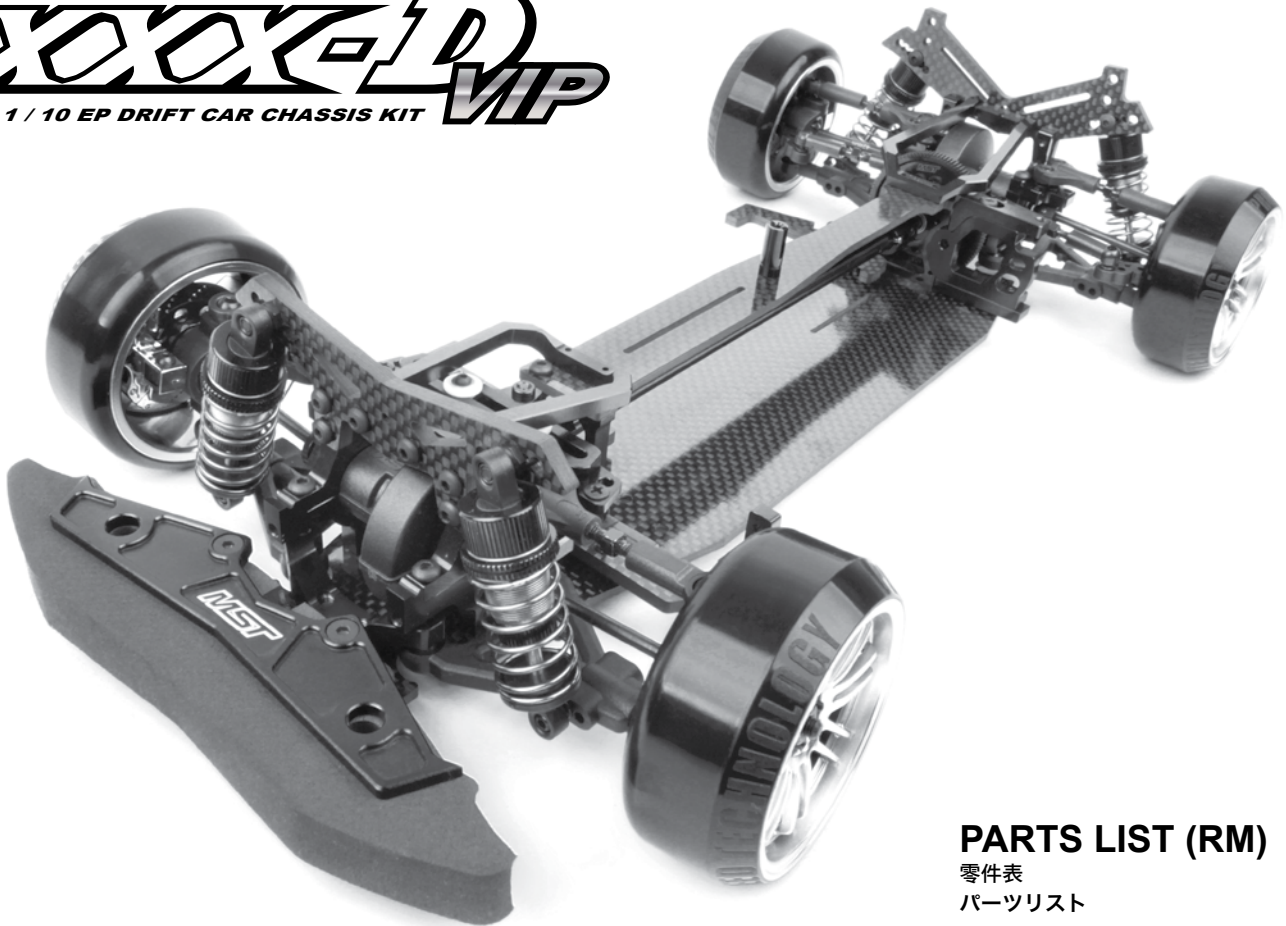

## PARTS LIST (RM)

零件表  
パーツリスト

※ Specifications are subject to change without notice.

### PARTS CODE

110001	Round head socket screw M3×6 (10)	120001	Ball bearing 10×15 (4)	210144	Coil spring set 28mm (8)	210226R	XXX Alum lower arm mount (red)
110002	Round head socket screw M3×8 (10)	120002	Ball bearing 5×10 (4)	210144-1	Coil spring set 28mm (hard) (silver) (2)	210227R	XXX Alum upper deck support (red)
110003	Round head socket screw M2.5×6 (6)	120005	Ball bearing 3×6 (4)	210144-2	Coil spring set 28mm (medium) (gold) (2)	210228R	XXX Alum upper deck cover (red)
110004	Round head socket screw M2×4 (6)	120007	Ball bearing 8×14 (2)	210144-3	Coil spring set 28mm (soft) (red) (2)	210229R	XXX Alum motor mount set (red)
110005	Countersunk hex head screw M3×8 (10)	130001	O-ring 3mm (10)	210144-4	Coil spring set 28mm (super soft) (white) (2)	210230R	XXX Alum spur gear holder (red)
110007	Drub screw M3×6 (6)	130002	O-ring 11.5×1.5 (4)	210145R	Brake calipers (red) (4)	210232	XXX Alum steering arm set
110009	Drub screw M3×20 (6)	130004	Oil seal (4)	210146	Steel CVD universal shaft set (2)	210233	Carbon damper support extension
110011	Cap screw M3×6 (6)	130006	Double sided tape (5)	210151	Alum damper cylinder (4)	210234R	XXX Alum gear box cover (red)
110013	E-clip E2.0 (10)	130007	Antenna pipe (2)	210159	5.8x4mm ball connector (4)	210235	Piston spacer set
110015	Flange nut M4 (4)	130008	Black grease	210161	4.8mm ball connector nut (4)	210236	Steering rail spacer set
110016	R-clip R6 (10)	130011	Tools	210165R	Alum turn-buckle shaft 3x20mm (red) (2)	210238	Alum propeller shaft joint (2)
110017	Shaft 2×9.8 (10)	130015	O-ring 3.5×1mm (10)	210167R	Alum turn-buckle shaft 3x25mm (red) (2)	210240	Rail spacer (2)
110019	Shaft 2×11.8 (10)	130019	O-ring 96×3	210168R	Steel turn-buckle shaft 3x25mm (red) (2)	310001	Ball connector 4.8 X 4.5 (5)
110021	Lock Nut M3 (5)	130020	XXX bumper	210190	Reinforced suspension arm set (2)	310003R	Cylinder cap (red) (2)
110024	Countersunk hex head screw M3×6 (10)	130021	6.5×2 sponge (10)	210193	Cross joint (4)	310004R	Spring retainer (red) (2)
110025	Taping screw 2.6×10 (6)	130022	Damper oil 150#	210194	Steel CVD universal shaft (2)	310005R	Rod guide cap (red) (2)
110026	Round head socket screw M3×10 (10)	210002	C PARTS	210206	Alum antenna pipe mount (generalized)	310006	Wheel axle (2)
110029	Round head socket screw M3×12 (6)	210005	F PARTS	210213	XXX Carbon front damper stay	310008	Piston rod (4)
110035	Drub screw M3×3 (6)	210007	H PARTS	210214	XXX Carbon rear damper stay	310018R	Alum spacer 3x5.5x1.0 (red)
110038	Flat head screw M3×7 (10)	210008	I PARTS	210215	XXX Carbon upper deck set	310020	Spacer 3×5×0.1mm (8)
110039	Cap screw M1.6×4 (10)	210025	Bevel gear set (40-16)	210216	XXX Carbon battery holder set	310021	Spacer 3×5×0.3mm (8)
110042	Countersunk hex head screw M2×6 (10)	210026	Bevel gear set (34-18)	210217	XXX Carbon lower deck set	310024	Spacer 10×12×0.1mm (8)
110043	Countersunk hex head screw M3×12 (10)	210029	Body post extension mount 4mm	210219R	XXX Alum propeller shaft (red)	310025	Spacer 10×12×0.3mm (8)
110044	Round head socket screw M2×6 (10)	210030	Bevel gear dust cover set	210221R	XXX Alum one way unit (RM) (red)	310028R	Alum spacer 3x5.5x3.0 (red)
110045	Round head socket screw M2×8 (10)	210031	Adjuster set 5.8×26	210223R	XXX Alum spool unit (red)	310029	Rail post (2)
110046	Shaft 2×9.8 (10)	210033	Servo horn set (long)	210224	XXX Spool joint	310030	Bevel gear - long abor
110047	Spacer 3×6×0.5 (10)	210108R	Alum turn-buckle shaft 3x28mm (red) (2)	210225R	XXX Alum gear B box (red)	310031	Bevel gear - short abor
110048	Spacer 3×8×0.5 (10)	210121-1	Swing Shaft Protector (4)				
110049	Round head socket screw M3×5 (10)	210142R	Alum bumper support (red)				
110050	Round head socket screw M2×5 (10)	210143	Alum Wheel Hubs (brake disc shaped) (4)				
110051	Flat head screw M3×5 (10)						
110052	Countersunk hex head screw M3×10 (10)						

### OPTION PARTS CODE

210118	Alum upright (2)	210154-3	Coil spring 21mm (soft) (red) (2)	210205	DK Coil spring set 30mm	210237	XXX Alum RM servo mount set
210137	4mm Turnbuckle wrench	210154-4	Coil spring 21mm (super soft) (white) (2)	210205-1	DK Coil spring 30mm (hard) (silver) (2)	210239	Alum front upright (2)
210145	Brake calipers (4)	210157	Alum CVD universal shaft set (2)	210205-2	DK Coil spring 30mm (medium) (gold) (2)		
210145B	Brake calipers-blue (4)	210163	Alum hex wheel hubs (4)	210205-3	DK Coil spring 30mm (soft) (red) (2)		
210145GD	Brake calipers-gold (4)	210195	Alum CVD universal shaft (2)	210205-4	DK Coil spring 30mm (super soft) (white) (2)		
210154	Coil spring set 21mm (8)	210198	Steel turn-buckle shaft 3x28mm (2)	210221R	XXX Alum one way unit (RM) (red)		
210154-1	Coil spring 21mm (hard) (silver) (2)			210231R	XXX Alum FM steering arm set (red)		
210154-2	Coil spring 21mm (medium) (gold) (2)						

Please add color remark for() part number.  
 e.g. 210123R for Red (210123)

Color	Remark
Red	R
Black	BK
Silver	S
Blue	B

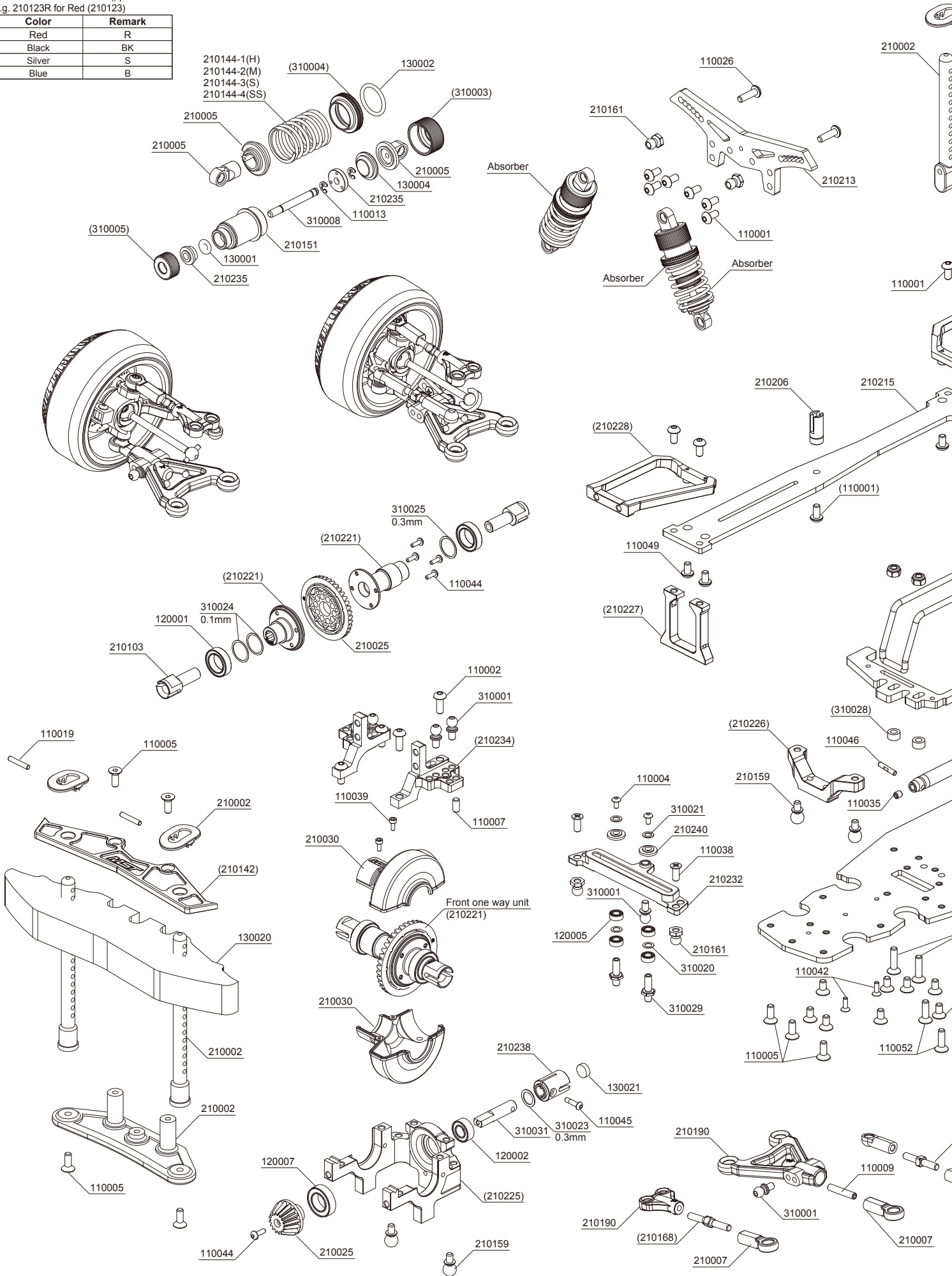

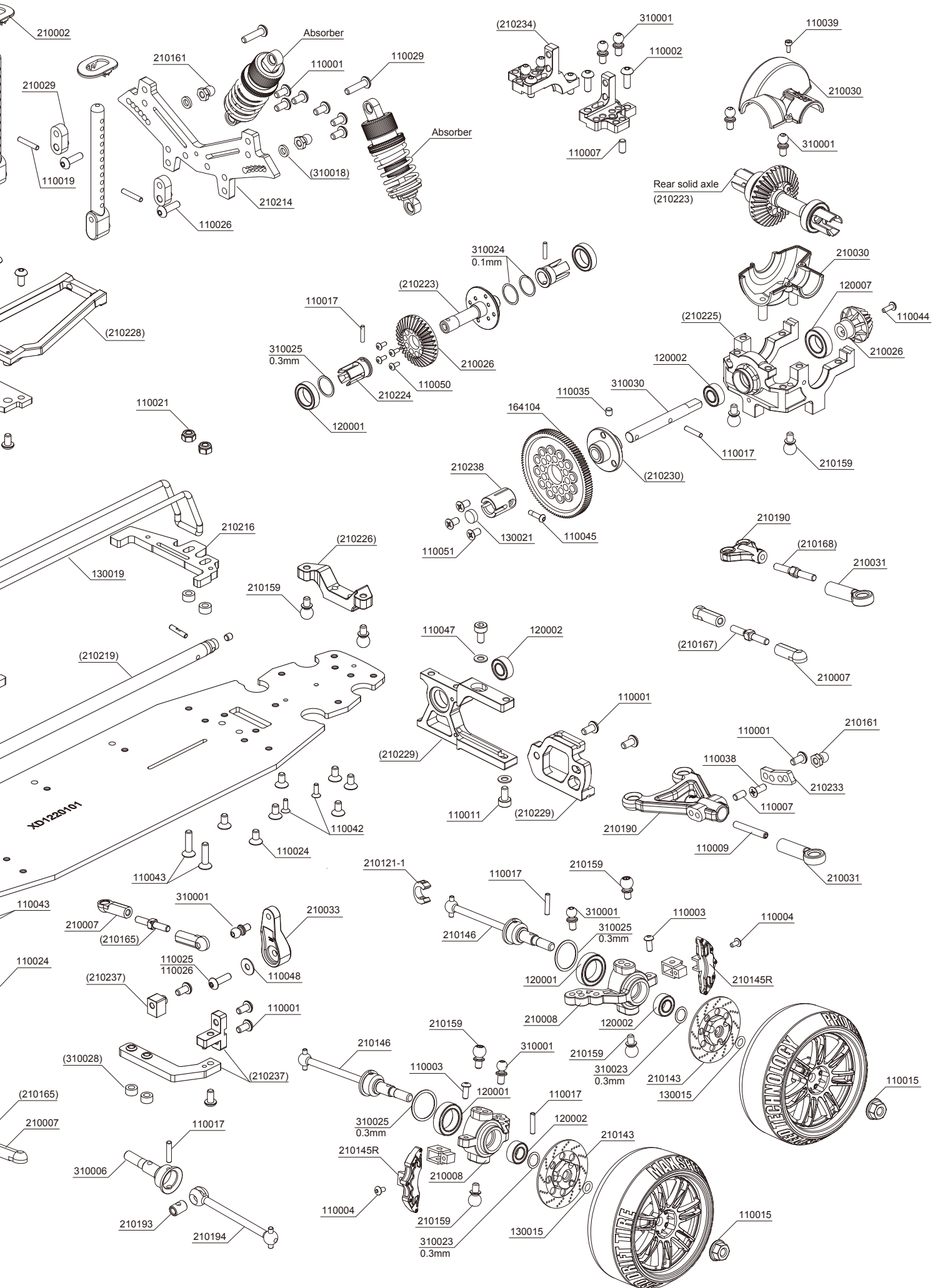

# PARTS

## A PARTS

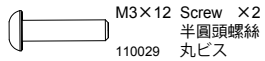

M3×12 Screw ×2  
半圓頭螺絲  
丸ビス  
110029

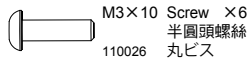

M3×10 Screw ×6  
半圓頭螺絲  
丸ビス  
110026

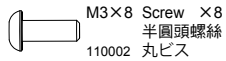

M3×8 Screw ×8  
半圓頭螺絲  
丸ビス  
110002

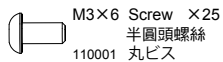

M3×6 Screw ×25  
半圓頭螺絲  
丸ビス  
110001

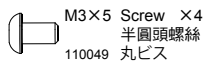

M3×5 Screw ×4  
半圓頭螺絲  
丸ビス  
110049

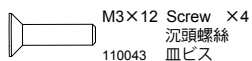

M3×12 Screw ×4  
沉頭螺絲  
皿ビス  
110043

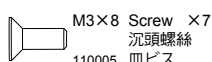

M3×8 Screw ×7  
沉頭螺絲  
皿ビス  
110005

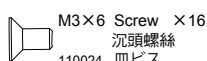

M3×6 Screw ×16  
沉頭螺絲  
皿ビス  
110024

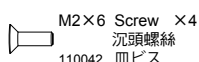

M2×6 Screw ×4  
沉頭螺絲  
皿ビス  
110042

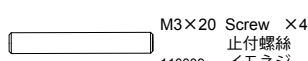

M3×20 Screw ×4  
止付螺絲  
イモネジ  
110009

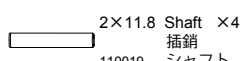

2×11.8 Shaft ×4  
插銷  
シャフト  
110019

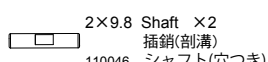

2×9.8 Shaft ×2  
插銷(割溝)  
シャフト(穴つき)  
110046

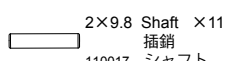

2×9.8 Shaft ×11  
插銷  
シャフト  
110017

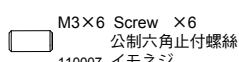

M3×6 Screw ×6  
公制六角止付螺絲  
イモネジ  
110007

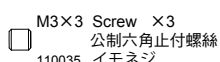

M3×3 Screw ×3  
公制六角止付螺絲  
イモネジ  
110035

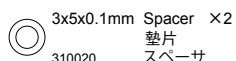

3x5x0.1mm Spacer ×2  
墊片  
スペーサ  
310020

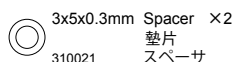

3x5x0.3mm Spacer ×2  
墊片  
スペーサ  
310021

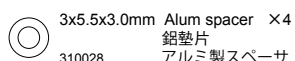

3x5.5x3.0mm Alum spacer ×4  
鋁墊片  
アルミ製スペーサ  
310028

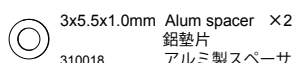

3x5.5x1.0mm Alum spacer ×2  
鋁墊片  
アルミ製スペーサ  
310018



3x6x0.5mm Spacer ×6  
墊片  
スペーサ  
110047

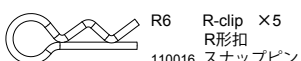

R6 R-clip ×5  
R形扣  
スナップピン  
110016

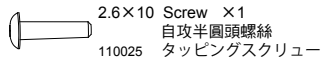

2.6×10 Screw ×1  
自攻半圓頭螺絲  
タッピングスクリュー  
110025

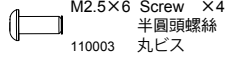

M2.5×6 Screw ×4  
半圓頭螺絲  
丸ビス  
110003

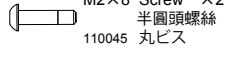

M2×8 Screw ×2  
半圓頭螺絲  
丸ビス  
110045

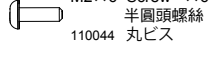

M2×6 Screw ×6  
半圓頭螺絲  
丸ビス  
110044

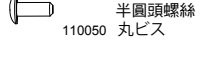

M2×5 Screw ×4  
半圓頭螺絲  
丸ビス  
110050

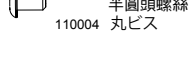

M2×4 Screw ×6  
半圓頭螺絲  
丸ビス  
110004

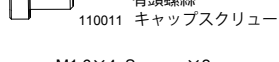

M3×6 Screw ×2  
有頭螺絲  
キャップスクリュー  
110011

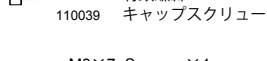

M1.6×4 Screw ×2  
有頭螺絲  
キャップスクリュー  
110039

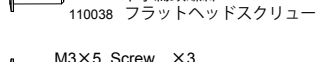

M3×7 Screw ×4  
十字扁頭螺絲  
フラットヘッドスクリュー  
110038

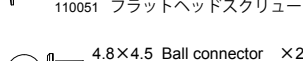

M3×5 Screw ×3  
十字扁頭螺絲  
フラットヘッドスクリュー  
110051

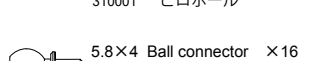

4.8×4.5 Ball connector ×20  
球頭螺絲  
ビロボール  
310001

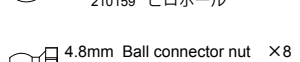

5.8×4 Ball connector ×16  
球頭螺絲  
ビロボール  
210159

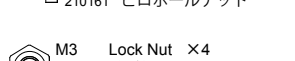

4.8mm Ball connector nut ×8  
球頭螺帽  
ビロボールナット  
210161

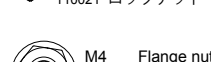

M3 Lock Nut ×4  
防鬆螺帽  
ロックナット  
110021

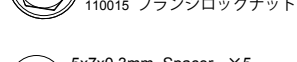

M4 Flange nut ×4  
凸緣螺帽  
フランジロックナット  
110015

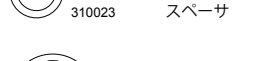

5x7x0.3mm Spacer ×5  
墊片  
スペーサ  
310023

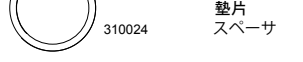

10x12x0.1mm Spacer ×4  
墊片  
スペーサ  
310024

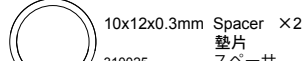

10x12x0.3mm Spacer ×2  
墊片  
スペーサ  
310025

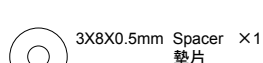

3x8x0.5mm Spacer ×1  
墊片  
スペーサ  
110048

## B PARTS

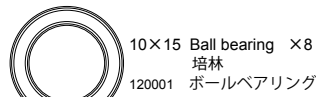

10×15 Ball bearing ×8  
培林  
120001 ボールベアリング



8×14 Ball bearing ×2  
培林  
120007 ボールベアリング

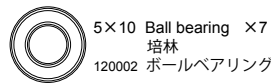

5×10 Ball bearing ×7  
培林  
120002 ボールベアリング

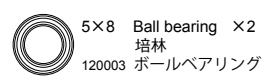

5×8 Ball bearing ×2  
培林  
120003 ボールベアリング

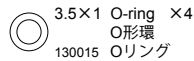

3.5×1 O-ring ×4  
O形環  
130015 Oリング

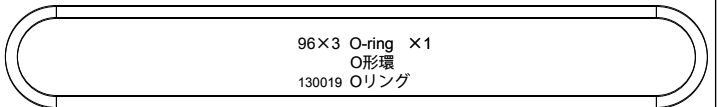

96×3 O-ring ×1  
O形環  
130019 Oリング



XXX Bumper ×1  
XXX 防撞泡棉  
XXX バンパー  
130020

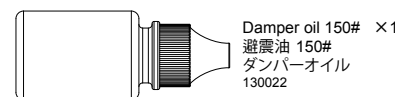

Damper oil 150# ×1  
避震油 150#  
ダンパーオイル  
130022

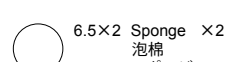

6.5×2 Sponge ×2  
泡棉  
130021 スポンジ

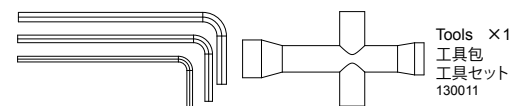

Tools ×1  
工具包  
工具セット  
130011



Bumper ×1  
泡棉雙面膠  
スポンジ両面テープ  
130006

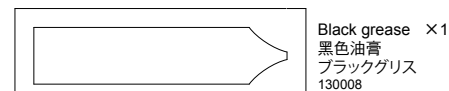

Black grease ×1  
黑色油膏  
ブラックグリス  
130008

## C PARTS

210002

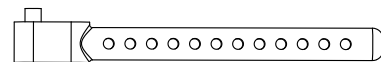
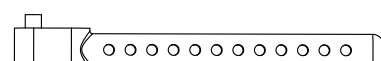
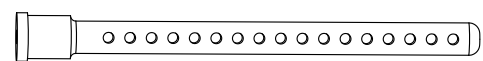
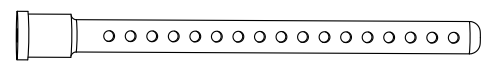
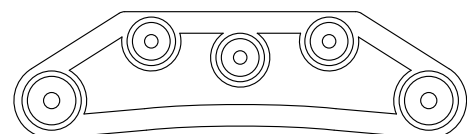

## D PARTS

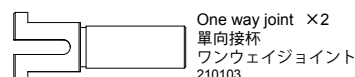

One way joint ×2  
單向接杯  
ワンウェイジョイント  
210103

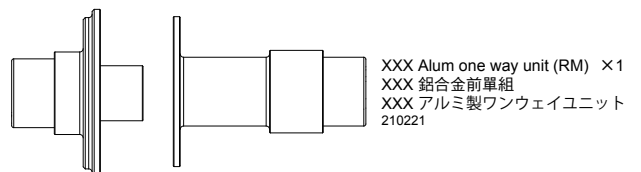

XXX Alum one way unit (RM) ×1  
XXX 鋁合金前單組  
XXX アルミ製ワンウェイユニット  
210221



# PARTS

## E PARTS

XXX Alum spool unit ×1  
XXX 鋁合金直軸組  
XXX アルミ製スプールユニット  
210223

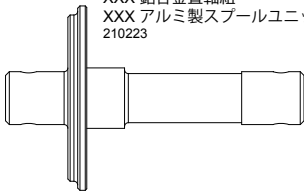

Swing Shaft Protector ×2  
直軸軸套  
スイングシャフトプロテクター  
210121-1



XXX Spool joint ×2  
XXX 直軸接杯  
XXX スプールジョイント  
210224

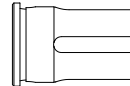

## G PARTS ×4

210190

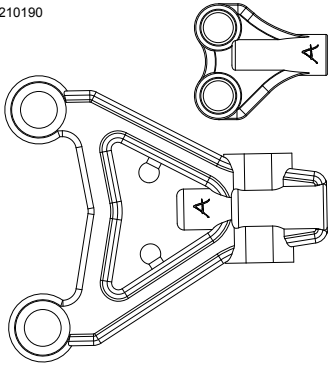

## H PARTS ×2

210007

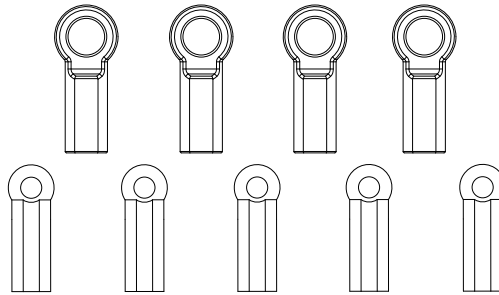

## I PARTS ×2

210008

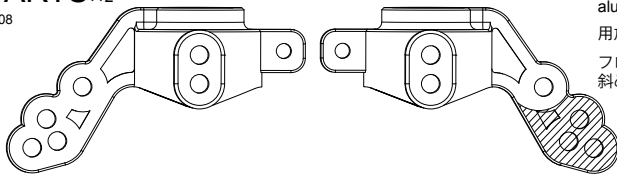

Please cut off the diagonal place for alum front upright using.

用於前輪座時請將斜線處切除

フロントアップライトを取り付ける際に、斜め線の部分を切って下さい。

## J PARTS

3×25 Steel turn-buckle shaft ×4  
鋼可調拉桿  
210168 スチール製ターンバックルシャフト



3×25 Alum turn-buckle shaft ×2  
鋁製可調拉桿  
210167 アルミ製ターンバックルシャフト



3×20 Alum turn-buckle shaft ×3  
鋁製可調拉桿  
210165 アルミ製ターンバックルシャフト



## L PARTS

XXX Alum upper deck cover ×2  
XXX 鋁合金二樓板上蓋  
XXX アルミ製アッパーデッキカバー  
210228

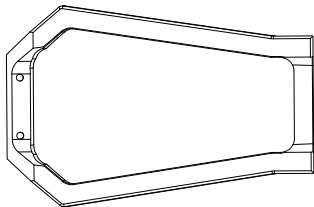

XXX Alum upper deck support ×1  
XXX 鋁合金二樓板支架  
XXX アルミ製アッパーデッキサポーター  
210227

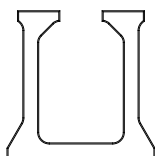

XXX Alum RM servo mount set ×1  
XXX 鋁合金後置伺服機座組  
XXX アルミ製サーボマウントセット(リア置き)  
210237

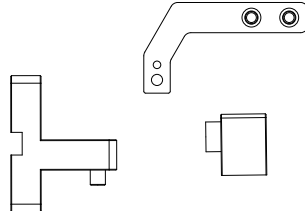

XXX Alum motor mount set ×1  
XXX 鋁合金馬達架組  
XXX アルミ製モーターマウントセット  
210229

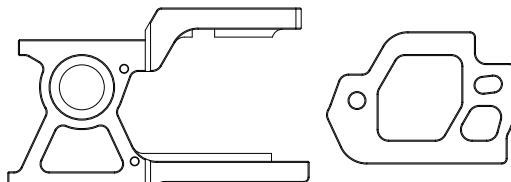

## F PARTS



Damper cap ×4  
避震器上球座  
ダンパーキャップ  
210005



Damper retainer ×4  
避震器下座  
ダンパーリテーナー  
210005

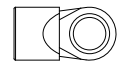

Damper adjuster ×4  
避震器下拉桿頭  
ダンパーアジャスター  
210005

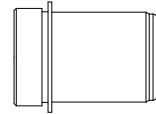

Alum damper cylinder ×4  
鋁合金避震筒身  
アルミ製ダンパーシリンダー  
210151

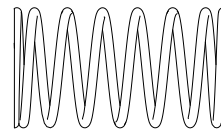

Coil spring set 28mm ×1  
避震彈簧組28mm  
コイルスプリングセット  
210144

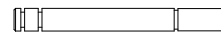

Piston rod ×4  
避震軸心  
ピストンロッド  
310008

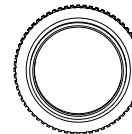

Spring retainer ×4  
避震器調整環  
スプリングリテーナー  
310004

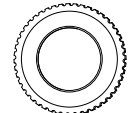

Cylinder cap ×4  
避震器上蓋  
シリンダーキャップ  
310003

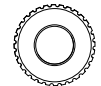

Rod guide cap ×4  
避震器下蓋  
ロッドガイドキャップ  
310005

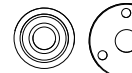

Piston spacer set ×4  
避震器活塞墊片組  
ピストンスペーサーセット  
210235

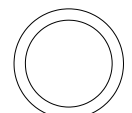

11.5X1.5 O-ring ×4  
O-ring  
Oリング

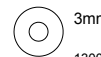

3mm O-ring ×4  
O-ring  
Oリング

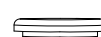

Oil seal ×4  
避震氣室  
オイルシール  
130004



E-clip ×8  
E形扣  
Eリング  
110013

# PARTS

## K PARTS

Carbon damper support extension ×2  
 碳纖維避震支點延伸片  
 カーボン製ダンパーサポート延長板  
 210233



XXX Carbon battery holder set ×2  
 XXX 碳纖維電池座組  
 XXX カーボン製バッテリーホルダーセット  
 210216

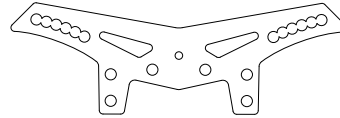
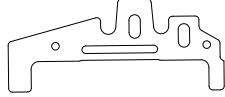

XXX Carbon front damper stay ×1  
 XXX 碳纖維前避震架  
 XXX カーボン製フロントダンパーステー  
 210213

XXX Carbon upper deck set ×1  
 XXX 碳纖維上樓板組  
 XXX カーボン製アッパーデッキセット  
 210215

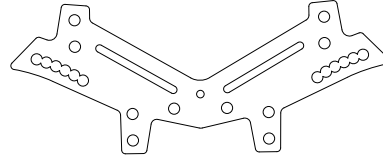
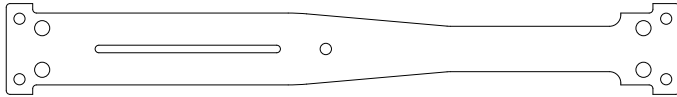

XXX Carbon rear damper stay ×1  
 XXX 碳纖維後避震架  
 XXX カーボン製リアダンパーステー  
 210214

XXX Carbon lower deck set ×1  
 XXX 碳纖維底盤組  
 XXX カーボン製シャーシセット  
 210217

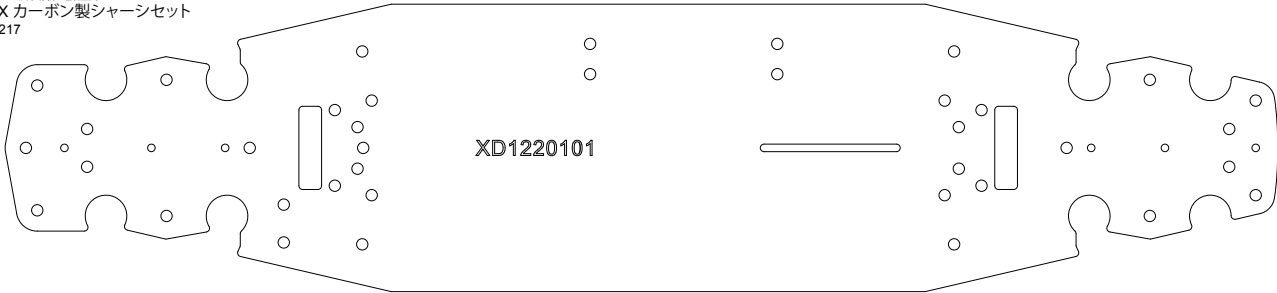

## M PARTS

Brake calipers ×1  
 煞車卡鉗  
 ブレーキキャリパー  
 210145

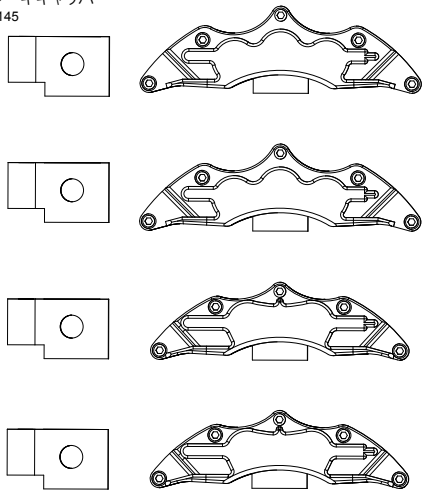

## N PARTS

XXX Alum spur gear holder ×1  
 XXX 鋁合金大齒盤座  
 XXX アルミ製ギアホルダー  
 210230

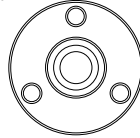

XXX Alum steering arm set ×1  
 XXX 鋁合金大轉向滑軌組  
 XXX アルミ製ステアリングアームセット  
 210232

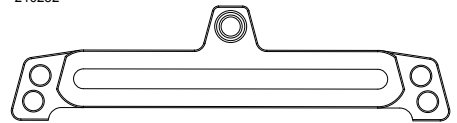

Alum antenna pipe mount (generalized) ×1  
 鋁合金天線管座 (通用型)  
 アルミ製アンテナパイプマウント (汎用型)  
 210206



XXX Alum gear box cover ×2  
 XXX 鋁合金齒箱上蓋  
 XXX アルミ製ギアボックス蓋  
 210234

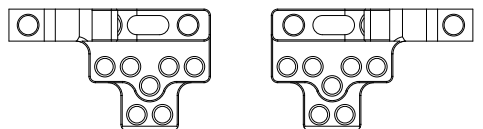

XXX Alum lower arm mount ×2  
 XXX 鋁合金下搖臂座  
 アルミ製ロワーアームマウント  
 210226

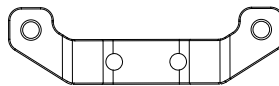

XXX Alum gear B box ×2  
 XXX 鋁合金傘齒箱  
 XXX アルミ製ギアボックス  
 210225

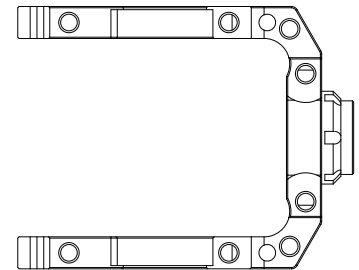

Alum Wheel Hubs (brake disc shaped) ×1  
 鋁合金制車碟六角輪座  
 アルミ製ブレーキディスク型ホイールハブ  
 210143

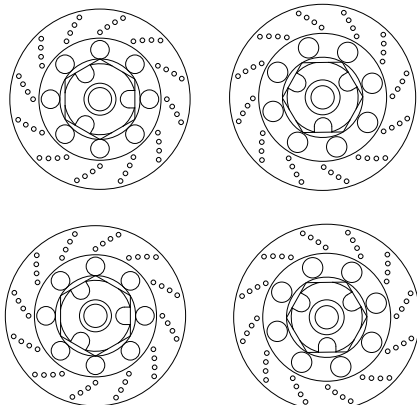

Alum bumper support ×1  
 鋁合金防撞板上蓋  
 アルミ製バンパーサポート  
 210142



# PARTS

## O PARTS

Bevel gear set (34-18) ×1  
傘歯組 (34-18)  
ベベルギアセット (34-18)  
210026

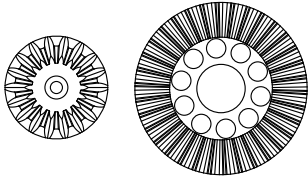

Bevel gear set (40-16) ×1  
傘歯組 (40-16)  
ベベルギアセット (40-16)  
210025

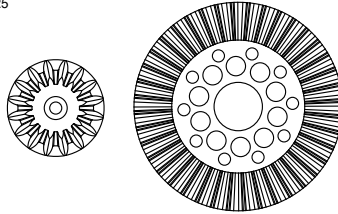

Spur gear (64P-104T) ×1  
大直歯 (64P-104T)  
スパークギア (64P-104T)  
164104

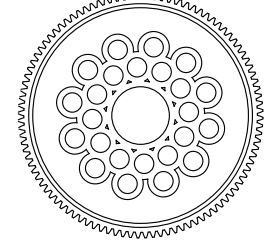

## P PARTS

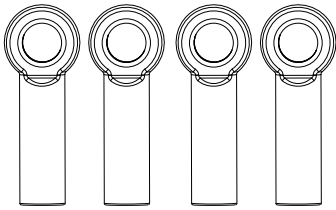

5.8×26 Adjuster set ×1  
拉桿頭組  
210031 アジャスターセット

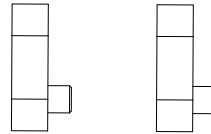

Body post extension mount 4mm ×1  
車殻柱延伸座 4mm  
ボディーポスト延長マウント  
210029

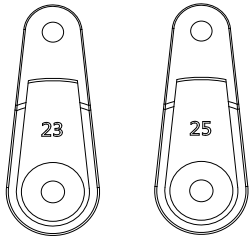

Servo horn set ×2  
伺服機片組  
サーボホーンセット  
210033

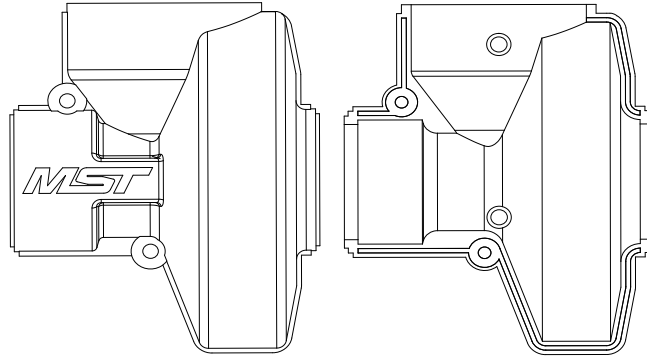

Bevel gear dust cover set ×2  
歯傘防塵殻組  
ベベルギア防塵カバーセット  
210030

## Q PARTS

XXX Alum propeller shaft ×1  
XXX 鋁合金中傳軸  
XXX アルミ製プロペラシャフト  
210219



Bevel gear - short abor ×1  
齒傘短軸  
ベベルギア-短軸  
310031



Bevel gear - long abor ×1  
齒傘長軸  
ベベルギア-長軸  
310030



XXX Alum propeller shaft joint ×2  
XXX 鋁合金中軸接杯  
XXX アルミ製プロペラシャフトジョイント  
210238

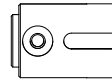

Rail post ×2  
滑軌支柱  
レールポスト  
310029

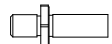

Wheel axle ×4  
萬向接杯  
ホイールアクスル  
310006

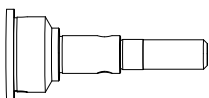

Cross joint ×4  
連接軸  
クロスバイダー  
210193



Steel CVD universal shaft ×4  
鋼製 CVD 傳動軸  
スチールCVDユニバーサルシャフト  
210194

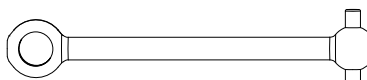

部品編號

Table listing various parts with columns for part number, name, and description. Includes items like screws, nuts, washers, and bearings.

改裝品編號

Table listing modification parts with columns for part number, name, and description. Includes items like springs, dampers, and brackets.

パーツリスト (零件清單)

Large table listing all parts for the vehicle with columns for part number, name, and description. Includes components like bearings, springs, dampers, and suspension parts.

オプションパーツリスト (改裝品清單)

Table listing optional modification parts with columns for part number, name, and description. Includes items like coil springs, dampers, and suspension kits.



more information

[ www.rc-mst.com ]

